



ISSN 2409-9074

# ЗБІРНИК НАУКОВИХ ПРАЦЬ

Серія: ГАЛУЗЕВЕ МАШИНОБУДУВАННЯ,  
БУДІВНИЦТВО

Випуск 1 (52)' 2019

---

# ACADEMIC JOURNAL

Series: INDUSTRIAL MACHINE BUILDING,  
CIVIL ENGINEERING

Issue 1 (52)' 2019



**Міністерство освіти і науки України  
Полтавський національний технічний університет  
імені Юрія Кондратюка**

---

**Ministry of Education and Science of Ukraine  
Poltava National Technical Yuri Kondratyuk University**

# **ЗБІРНИК НАУКОВИХ ПРАЦЬ**

**Серія: ГАЛУЗЕВЕ МАШИНОБУДУВАННЯ,  
БУДІВНИЦТВО**

**Випуск 1 (52)' 2019**

---

# **ACADEMIC JOURNAL**

**Series: INDUSTRIAL MACHINE BUILDING,  
CIVIL ENGINEERING**

**Issue 1 (52)' 2019**

**Полтава – 2019**

---

**Poltava - 2019**



[www.znp.pntu.edu.ua](http://www.znp.pntu.edu.ua)  
<http://journals.pntu.edu.ua/znp>

## **Збірник наукових праць. Серія: Галузеве машинобудування, будівництво / Полтавський національний технічний університет імені Юрія Кондратюка**

Збірник наукових праць видається з 1999 р., періодичність – двічі на рік.

Засновник і видавець – Полтавський національний технічний університет імені Юрія Кондратюка.

Свідоцтво про державну реєстрацію КВ 8974 від 15.07.2004 р.

Збірник наукових праць уключений до переліку наукових фахових видань, у яких можуть публікуватися результати дисертаційних робіт (Наказ МОН України №1279 від 06.11.2014 року).

Збірник наукових праць рекомендовано до опублікування вченою радою Полтавського національного технічного університету імені Юрія Кондратюка, протокол № 18 від 05.07.2019 р.

У збірнику представлені результати наукових і науково-технічних розробок у галузі машинобудування, автомобільного транспорту та механізації будівельних робіт; із проектування, зведення, експлуатації та реконструкції будівельних конструкцій, будівель і споруд; їх основ та фундаментів; будівельної фізики та енергоефективності будівель і споруд.

Призначений для наукових й інженерно-технічних працівників, аспірантів і магістрів.

### **Редакційна колегія:**

<i>Пічугін С.Ф.</i>	– <i>головний редактор</i> , д.т.н., професор, Полтавський національний технічний університет імені Юрія Кондратюка (Україна), pichugin.sf@gmail.com
<i>Винников Ю.Л.</i>	– <i>заступник головного редактора</i> , д.т.н., професор, Полтавський національний технічний університет імені Юрія Кондратюка (Україна), vunnikov@ukr.net
<i>Ільченко В.В.</i>	– <i>відповідальний секретар</i> , к.т.н., доцент, Полтавський національний технічний університет імені Юрія Кондратюка (Україна), znpbud@gmail.com
<i>Болтрік М.</i>	– д.т.н., професор, Білостоцький технологічний університет (Польща)
<i>Ємельянова І.А.</i>	– д.т.н., професор, Харківський національний університет будівництва та архітектури (Україна)
<i>Галінська Т.А.</i>	– к.т.н., доцент, Полтавський національний технічний університет імені Юрія Кондратюка (Україна)
<i>Гасімов А.Ф.</i>	– к.т.н., доцент, Азербайджанський архітектурно-будівельний університет (Азербайджан)
<i>Качинський Р.</i>	– д.т.н., професор, Білостоцький технологічний університет (Польща)
<i>Коробко Б.О.</i>	– д.т.н., професор, Полтавський національний технічний університет імені Юрія Кондратюка (Україна)
<i>Косіор-Казберук М.</i>	– д.т.н., професор, Білостоцький технологічний університет (Польща)
<i>Камал М.А.</i>	– д.т.н., доцент, Мусульманський університет Алігарха (Індія)
<i>Молчанов П.О.</i>	– к.т.н., доцент, Полтавський національний технічний університет імені Юрія Кондратюка (Україна)
<i>Назаренко І.І.</i>	– д.т.н., професор, Київський національний університет будівництва та архітектури (Україна)
<i>Нестеренко М.П.</i>	– д.т.н., професор, Полтавський національний технічний університет імені Юрія Кондратюка (Україна)
<i>Павліков А.М.</i>	– д.т.н., професор, Полтавський національний технічний університет імені Юрія Кондратюка (Україна)
<i>Погрібний В.В.</i>	– к.т.н., с.н.с., Полтавський національний технічний університет імені Юрія Кондратюка (Україна)
<i>Савик В.М.</i>	– к.т.н., доцент, Полтавський національний технічний університет імені Юрія Кондратюка (Україна)
<i>Семко О.В.</i>	– д.т.н., професор, Полтавський національний технічний університет імені Юрія Кондратюка (Україна)
<i>Шаповал В.Г.</i>	– д.т.н., професор, Національний гірничий університет (Україна)
<i>Стороженко Л.І.</i>	– д.т.н., професор, Полтавський національний технічний університет імені Юрія Кондратюка (Україна)
<i>Сулевська М.</i>	– д.т.н., професор, Білостоцька політехніка (Польща)
<i>Тур В.В.</i>	– д.т.н., професор, Брестський державний технічний університет (Білорусь)
<i>Васильєв Є.А.</i>	– к.т.н., доцент, Полтавський національний технічний університет імені Юрія Кондратюка (Україна)
<i>Вінеке-Тумауі Б.</i>	– д.т.н., професор, Університет прикладних наук м. Банденбург (Німеччина)
<i>Панг С.</i>	– к.т.н., професор, Китайський університет нафти – Пекін (Китай)
<i>Жусупбеков А.Ж.</i>	– д.т.н., професор, Євразійський національний університет ім. Л.М. Гумільова (Казахстан)
<i>Зоценко М.Л.</i>	– д.т.н., професор, Полтавський національний технічний університет імені Юрія Кондратюка (Україна)
<i>Зурло Франческо</i>	– д.т.н., професор, Міланська політехніка (Італія)

Адреса видавця та редакції – Полтавський національний технічний університет імені Юрія Кондратюка

Науково-дослідницька частина, к. 320Ф, Першотравневий проспект, 24, м. Полтава, 36011.

тел.: (05322) 29875; e-mail: v171@pntu.edu.ua; www.pntu.edu.ua

Макет та тиражування виконано у поліграфічному центрі

Полтавського національного технічного університету імені Юрія Кондратюка,

Першотравневий проспект, 24, м. Полтава, 36011.

Свідоцтво про внесення суб'єкта видавничої справи до державного реєстру видавців,

видавничих і розповсюджувачів видавничої продукції (ДК № 3130 від 06.03.2008 р.).

Комп'ютерна верстка – В.В. Ільченко. Коректори – Я.В. Новічкова, М.В. Москаленко.

Підписано до друку 09.07.2019 р.

Папір ксерокс. Друк різнограф. Формат 60x80 1/8. Ум. друк. арк. – 27,32.

Тираж 300 прим.

## Academic journal. Series: Industrial Machine Building, Civil Engineering / Poltava National Technical Yuri Kondratyuk University

Academic journal was founded in 1999, the publication frequency of the journal is twice a year.

Founder and Publisher is Poltava National Technical Yuri Kondratyuk University.

State Registration Certificate KB № 8974 dated 15.07.2004.

Academic journal is included into the list of specialized academic publications where graduated thesis results could be presented (Order of Department of Education and Science of Ukraine № 1279 dated 06.11.2014).

Academic journal was recommended for publication by the Academic Board of Poltava National Technical Yuri Kondratyuk University, transactions № 18 of 05.07.2019.

The results of scientific and scientific-technical developments in the sphere of mechanical engineering, automobile transport and mechanization of construction works; designing, erection, operation and reconstruction of structural steels, buildings and structures; its bases and foundations; building physics and energy efficiency of buildings and structures are presented in the collection.

Academic journal is designed for researchers and technologists, postgraduates and senior students.

### Editorial Board:

<i>Pichugin Sergiy</i>	– <i>Editor-in-Chief</i> , DSc, Professor, Poltava National Technical Yuri Kondratyuk University (Ukraine), pichugin.sf@gmail.com
<i>Vynnykov Yuriy</i>	– <i>Deputy Editor</i> , DSc, Professor, Poltava National Technical Yuri Kondratyuk University (Ukraine), vynnykov@ukr.net
<i>Ilchenko Volodymyr</i>	– <i>Executive Secretary</i> , PhD, Associate Professor, Poltava National Technical Yuri Kondratyuk University (Ukraine), znpbud@gmail.com
<i>Boltryk Michal</i>	– DSc, Professor, Dean of the Faculty of Civil and Environmental Engineering, Bialystok Technological University (Poland)
<i>Emeljanova Inga</i>	– DSc, Professor, Professor of Mechanization of Construction Processes Department, Kharkiv National University of Construction and Architecture (Ukraine)
<i>Galinska Tatiana</i>	– PhD, Associate Professor, Associate Professor of Architecture and Town Planning Department, Poltava National Technical Yuri Kondratyuk University (Ukraine)
<i>Gasimov Akif</i>	– PhD, Associate Professor, Vice-Rector for Academic Work, Azerbaijan Architectural and Construction University (Azerbaijan)
<i>Kaczyński Roman</i>	– DSc, Professor, Vice-Rector for Development, Bialystok Technological University (Poland)
<i>Korobko Bogdan</i>	– DSc, Professor, Professor of Building Machines and Building Equipment Department, Poltava National Technical Yuri Kondratyuk University (Ukraine)
<i>Kosior-Kazberuk Marta</i>	– DSc, Professor, Vice-Rector for Education and International Cooperation, Bialystok Technological University (Poland)
<i>Kamal Mohammad Arif</i>	– DSc, Associate Professor, Architecture Section, Aligarh Muslim University (India)
<i>Molchanov Petro</i>	– PhD, Associate Professor, Associate Professor of Equipment of Oil and Gas Fields Department, Poltava National Technical Yuri Kondratyuk University (Ukraine)
<i>Nazarenko Ivan</i>	– DSc, Professor, Head of Technological Processes Mechanization Department, Kyiv National Civil Engineering and Architecture University (Ukraine)
<i>Nesterenko Mykola</i>	– DSc, Professor, Professor of Building Machines and Building Equipment Department, Poltava National Technical Yuri Kondratyuk University (Ukraine)
<i>Pavlikov Andriy</i>	– DSc, Professor, Head of Reinforced Concrete and Masonry Structures and Strength of Materials Department, Poltava National Technical Yuri Kondratyuk University (Ukraine)
<i>Pohribnyi Volodymyr</i>	– PhD, Associate Professor of Reinforced Concrete and Masonry Structures and Strength of Materials Department, Poltava National Technical Yuri Kondratyuk University (Ukraine)
<i>Savyl Vasyl</i>	– PhD, Associate Professor, Associate Professor of Equipment of Oil and Gas Fields Department, Poltava National Technical Yuri Kondratyuk University (Ukraine)
<i>Semko Oleksandr</i>	– DSc, Professor, Head of Architecture and Town Planning Department, Poltava National Technical Yuri Kondratyuk University (Ukraine)
<i>Shapoval Volodymyr</i>	– DSc, Professor, Professor of Civil Engineering and Geomechanics Department, National Mining University (Ukraine)
<i>Storozhenko Leonid</i>	– DSc, Professor, Professor of Metal, Wood and Plastics Structures Department, Poltava National Technical Yuri Kondratyuk University (Ukraine)
<i>Sulewska Maria</i>	– DSc, Professor of Geotechnical Department, Bialystok University of Technology (Poland)
<i>Tur Viktor</i>	– DSc, Professor, Head of Concrete Technology and Building Materials, Brest State Technical University (Belarus)
<i>Vasyliov Ievgen</i>	– PhD, Associate Professor, Associate Professor of Building Machines and Equipment Department, Poltava National Technical Yuri Kondratyuk University (Ukraine)
<i>Wieneke-Toutaoui Burghilde</i>	– DSc, Professor, President of Brandenburg University of Applied Sciences (Germany)
<i>Pang Xiongqi</i>	– PhD, Professor, State Key Laboratory of Oil and Gas Resource and Prospecting, Vice-president China University of Petroleum – Beijing (China)
<i>Zhusupbekov Askar</i>	– DSc, Professor, Head of Buildings and Structures Design Department, Director of Geotechnical Institute, Eurasia National L.N. Gumiliov University (Kazakhstan)
<i>Zotsenko Mykola</i>	– DSc, Professor, Head of Oil and Gas Extraction and Geotechnical Department, Poltava National Technical Yuri Kondratyuk University (Ukraine)
<i>Zurlo Francesco</i>	– PhD, Associate Professor of Department of Design, Polytechnic University of Milan (Italia)

Address of Publisher and Editorial Board – Poltava National Technical Yuri Kondratyuk University,

Research Centre, room 320-F, Pershotravnevyi Avenue, 24, Poltava, 36011, Ukraine.

tel.: (05322) 29875; e-mail: v171@pntu.edu.ua; www.pntu.edu.ua

Layout and printing made in the printing center of Poltava National Technical Yuri Kondratyuk University,  
Pershotravnevyi Avenue, 24, Poltava, 36011, Ukraine.

Registration certificate of publishing subject in the State Register of Publishers Manufacturers  
and Distributors of publishing products (DK № 3130 from 06.03.2008).

Desktop Publishing – V.V. Ilchenko. Corrections – Y.V. Novichkova, M.V. Moskalenko.

Authorize for printing 09.07.2019.

Paper copier. Print rizograf. Format 60x80 1/8. Conventionally printed sheets – 27,32.

Circulation 300 copies.

UDC 62-932.4

## Mathematical modeling for the technological process of surface soil compaction by the inertial vibratory rammer

Ivanchuk Yaroslav<sup>1\*</sup>

<sup>1</sup> Vinnytsia National Technical University <https://orcid.org/0000-0002-4775-6505>

\*Corresponding author E-mail: [ivanchuck@ukr.net](mailto:ivanchuck@ukr.net)

The high efficiency of the technological process of surface soil compaction using vibration and vibro-impact treatment has been determined. High degree intensification of the soil compaction process is achieved by using original inertial vibratory rammers with a hydro-pulse drive. A new mathematical model has been developed for the surface soil compaction processes study by the inertial vibratory rammers. Using numerical modeling, work dependencies are obtained to determine the main operating characteristics for the technological process of surface soil compaction by inertial vibratory rammers based on a hydro-impulse drive.

**Keywords:** rammer, compaction, shock, vibration, hydro-impulse drive, inertia, soil, valve.

## Математичне моделювання технологічного процесу поверхневого ущільнення ґрунтів інерційною вібротрамбівкою

Іванчук Я.В.<sup>1\*</sup>

<sup>1</sup> Вінницький національний технічний університет

\*Адреса для листування E-mail: [ivanchuck@ukr.net](mailto:ivanchuck@ukr.net)

Визначено високу ефективність технологічного процесу поверхневого ущільнення ґрунтів за допомогою вібраційної і віброударної обробки. Високого ступеню інтенсифікації процесу ущільнення ґрунтів досягнуто застосуванням розроблених оригінальних інерційних вібраційних трамбівок з гідроімпульсним приводом на базі двокаскадного клапана-пульсатора. Розроблено нову математичну модель для дослідження технологічних процесів поверхневого ущільнення ґрунтів інерційною вібротрамбівкою на базі законів гідродинаміки з використанням механореологічної феноменології й узагальнених законів механіки. При розробленні математичної моделі технологічний процес було досліджено на двох фазах: фаза накопичення кінетичної енергії, а також фаза ударної взаємодії інерційної трамбівки з поверхнею ґрунту. На основі розробленої математичної моделі методом кінцевих об'ємів за допомогою чисельного моделювання й методу припасовування отримано розподіл тиску і швидкості робочої рідини в гідроімпульсному приводі інерційної вібротрамбівки. Також було отримано діаграми зміни відносної й абсолютної швидкості рухомих елементів інерційної вібротрамбівки. Розроблена оригінальна модель поверхневого ущільнення ґрунтів дозволила одержати залежності зміни переміщення центрів мас шарів ущільнюючого ґрунту типу суглинків. Одержані робочі залежності основних робочих характеристик інерційної трамбівки на базі гідроімпульсного привода дозволили отримати основні робочі залежності для подальшого підвищення ефективності технологічного процесу поверхневого ущільнення ґрунтів. Отримані результати чисельного моделювання технологічних процесів поверхневого ущільнення ґрунтів інерційною вібротрамбівкою на базі гідроімпульсного привода показали переваги обраного підходу до проектування, а також дозволили довести ефективність розробленої конструкції.

**Ключові слова:** трамбівка, ущільнення, удар, вібрації, гідроімпульсний привід, інерція, ґрунт, клапан.



## Introduction

Technologies characterized by surface treatment processes where pseudo-fluidity of materials is realized [1, 2] with complex rheology and under inertial load conditions, require new developments, study and improvement. Vibrational and vibro-impact technological processes, as well as equipment for their implementation, are widely used [1]. It has been established that if useful vibrations or shock impulses to processing objects are applied, then it can be the flow of a number of technological processes can be significantly intensified, optimal load parameters can be ensured and processing results with high quality parameters can be obtained. In particular, during mechanical surface compaction (ramming), which consists of impacting the load on the soil that falls freely or at a forcibly developed speed, extreme compressive stresses appear in the soil, which cause pseudo-flowability and reorientation of the dispersed soil particles that leads to compaction soil.

Therefore, the study of the changes in the working influence and design parameters of inertial vibratory rammers from a hydro-impulse drive (HID) [1] on the flow of work processes in the surface soil compaction technology increase its effectiveness and outline ways for further development and improvement.

Currently, it is widely used mathematical modeling of workflows in various technological devices. With its help, it is possible to deeply and fully investigate the influence of structural and operational factors on the main characteristics of the device and outline specific ways to improve them, while significantly reducing the amount of experimental research.

## Review of research sources and publications

In [2, 3], on the basis of experimental studies, it was found that the best compaction of soils is usually achieved at values of amplitude vibration accelerations close to the acceleration of gravity. Under the action of attractive forces, inertial forces and static load axial forces, particles of a dispersed material tend to reorient and more densely fit each other in a given volume, accompanied by the occupation of more stable equilibrium positions. At the same time, the destruction of the initial structural formations of the «arches» and «bridges» types is observed, followed by a uniform conclusion of the particles forming them, which have an increased mobility in the direction of the static load force by reducing the effective coefficients of internal and lateral friction to zero. In [4, 5] there is researched a fluctuation model particle dispersion medium under the action of vibrations. The phenomena of «vibro-boiling» were analyzed, when a particle loses contact with a vibrating working body, and the bonds between particles decrease and are periodically broken. This state is characterized by loosening of the medium and enhanced circulation of the particles that make it up. The disadvantage of these scientific works is the lack of a mathematically-based behavior of dispersed materials under the action of vibration and vibro-impact load.

In the scientific work [6], a systematic approach to the technological process of forming vibration (VM) and vibro-impact machines (VIM) based on the HID was considered. It enabled to develop a mathematical model for its evaluation. Relationships between the parameters of subsystems on the basis of a vibropress equipment with a HID for forming blanks from powder materials are determined. Based on the mathematical model of fuzzy sets was estimated efficiency of the processing facility. But this technique does not enable to investigate the physicomaterial processes occurring directly in the equipment of the VM and VIM on the basis of the HID.

## Definition of unsolved aspects of the problem

Study of physico-mechanical processes that occur in the HID based on the calculations of motion's equations and expenses with a computer [6]. This method does not enable to evaluate the influence of hydrodynamic processes occurring in the executive and regulating units of the HID, despite the complexity of the calculations and the assumptions made in the mathematical description of the working process, which, as experimental data accumulate, can be refined.

Solving these problems is impossible without using the Navier-Stokes equation, which requires the use of the finite volume method to study the complex motion of the working fluid under different flow conditions [5]. Conducting such studies is based on modern methods of mathematical modeling with calculations on a computer using modern, advanced algorithms. It enables to prevent an unjustifiably large number of complex and expensive experimental studies, significantly reduce the time and cost of design work, conduct qualitative and quantitative assessments of physical phenomena with sufficient accuracy for engineering practice [1].

Therefore, the construction of a mathematical model that enables to describe the behavior of a dispersed medium under vibration and vibro-impact load under various operating modes of a HID on the inertial vibratory rammer with the aim of determining the basic performance characteristics of technological processing of building materials is an urgent task.

## Problem statement

The aim of the work is to increase the efficiency of theoretical research of the surface soil treatment technology through the development of promising mathematical models for the physical processes of inertial vibration compaction using HID-based devices.

To achieve this goal the following tasks were solved:

- to develop an effective inertial vibratory rammer with HID based on a two-stage pulsator valve. This will allow to realize the most effective modes of vibration impact on the processed media.
- develop the mathematical model for the technology of surface compaction of soils with inertial vibratory rammer based on the HID with a two-stage pulsator valve;

– on the basis of the developed mathematical model, to obtain working dependencies to determine the main characteristics of the studied technological process.

### Basic material and results

In Vinnytsia National Technical University, the Department of Industrial Engineering has developed inertial vibratory rammer based on the HID [7]. Figure 1 shows the three-dimensional CAD-model of inertial vibratory rammer based on the HID.

This installation consists of the following main structural elements: to tamping plate 1, through the outer walls 2, attached to the cover 3. The cover 3 is attached to the tamping plate 1 guides 4.

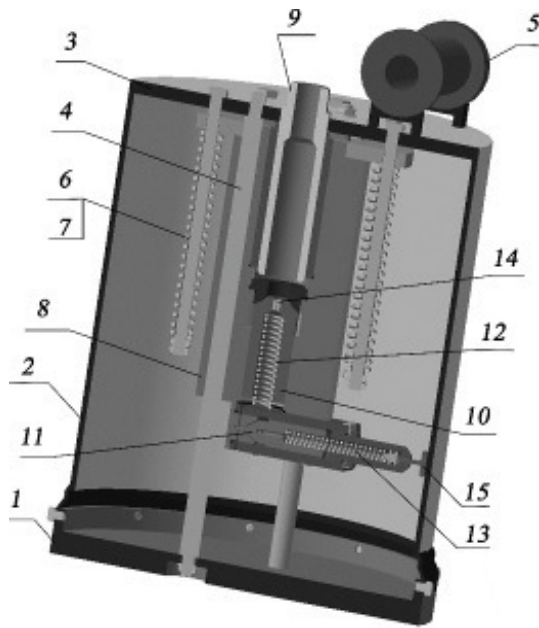


Figure 1 – Three-dimensional model of inertial vibratory rammer based on the HID

In turn, a fastening assembly 5 and a body of a two-stage pulsator valve 8 connected through a power springs 6 and power rails 7 are attached to the cover 3. The housing of the two-stage valve-pulsator 8 additionally performs the functions of a movable hydraulic cylinder in a fixed piston-guide 9. In the case of a two-stage pulsation valve 8 there is a valve of the second cascade 10 and a valve of the first cascade 11. Their mutual movement is regulated by springs 12 and 13, respectively, by the throttle 14 and the adjusting screw 15.

Figure 2 shows the three-component (flat multi-mass) inertial model with irresistible contacts between the masses. It enables to simulate the elastic-viscous properties of soil layers 1, 2, 3 along the  $x$  and  $y$  axes (the nature of the medium movement along the  $x$  and  $z$  axes is equivalent, therefore it is advisable to consider only the motion along the  $x, y$  axes).

Studies [8] show that oscillations from the working body 4 (see Fig. 2) (ramming plate 1 (see Fig. 1)) inertial vibratory rammer with a mass  $M$  are transmitted to

the upper layer of soil 1 touching it, with a concentrated mass  $m_1$ , and further below are located layers of soil 2, 3, with concentrated masses  $m_2, m_3$ . The frequency of oscillations of the entire mass of the soil layer 1 in the zone of vibrations is the same. And the amplitude decreases with distance from the surface of the working body until it goes out altogether.

Thus, a characteristic feature of the operation of inertial vibratory rammers is that the soil is subjected to the vibration effect in a limited area of the working body.

The dimensions of this zone are determined by the oscillation mode and the location of the inertial rammer itself, as well as the properties of the soil itself.

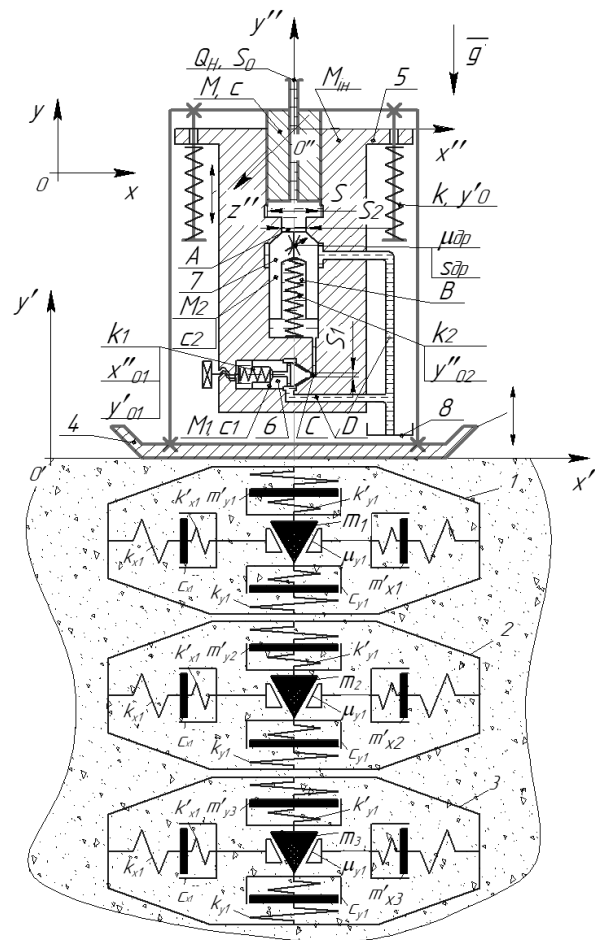


Figure 2 – Dynamic model for the technological process of surface compaction of soil by the inertial vibratory rammer with the HID

There are introduced two moving coordinate systems –  $x'O'y'$ , rigidly connected to the working body 4, and  $x''O''y''$ , rigidly connected to the hydraulic cylinder 5 (see Fig. 2) (the body of the two-stage pulsator valve 8 (see Fig. 1)). And also there is introduced the absolute (fixed) coordinate system  $xOy$ .

The system of equations (1) for the law of the movement of the soil layers 1, 2, 3 during the contact interaction of the working body 4 with the upper layer of soil 1 is shown in this system of equations:



$y_1$  – is the absolute coordinate of the working body position 4;

$y'_1, y'_2, y'_3, x'_1, x'_2, x'_3$  – coordinates of the soil masses layers 1, 2, 3;

$k_y = k_{y1} k'_{y1} / (k_{y1} + k'_{y1}), k_x = k_{x1} k'_{x1} / (k_{x1} + k'_{x1})$  – equivalent stiffness of soil layers 1, 2, 3, respectively;

$\mu_x, \mu_y$  – the projections of the internal friction coefficients on the  $x$  and  $y$  axes, respectively;

$c_{x1}, c_{y1}$  – component coefficients of viscosity along the  $x$  and  $y$  axes respectively;

$N_{1xy}, N_{2xy}, N_{3xy}$  – internal reaction forces within the concentrated masses  $m_1, m_2, m_3$  on wedge-shaped platforms at an angle of  $45^0$ ;

$m'_{x1} = m'_{y1} = 0$  – additional rheological masses;

$N_{1,4}(t) = k_y y'_1 + c_{y1} \dot{y}'_1$  – normal reaction of soil layer 1 to load carrier 4.

$$\left\{ \begin{array}{l} -m_1(\ddot{y}_1 + \ddot{y}'_1) = -N_{1,4}(t) + k_y(y'_1 - y'_2)_1 + \\ + c_{y1}(\dot{y}'_1 - \dot{y}'_2) - m_1 g + 2 \text{sign}(\dot{y}'_1) \mu_y N_{1xy}; \\ -m_2(\ddot{y}_1 + \ddot{y}'_2) = k_y(y'_2 - y'_1) + k_y(y'_2 - y'_3) + \\ + c_{y1}(\dot{y}'_2 - \dot{y}'_1) + c_{y1}(\dot{y}'_2 - \dot{y}'_3) - m_2 g + \\ + 2 \text{sign}(\dot{y}'_2) \mu_y N_{2xy}; \\ -m_3(\ddot{y}_1 + \ddot{y}'_3) = k_y(y'_3 - y'_2) + k_y y'_3 + \\ + c_{y1}(\dot{y}'_3 - \dot{y}'_2) + c_{y1} \dot{y}'_3 - m_3 g + 2 \text{sign}(\dot{y}'_3) \mu_y N_{3xy}; \\ m_1 \ddot{x}'_1 = -k_x x'_1 - c_{x1} \dot{x}'_1 + \text{sign}(\dot{y}'_1) \mu_x N_{1xy}; \\ m_2 \ddot{x}'_2 = -k_x x'_2 - c_{x1} \dot{x}'_2 + \text{sign}(\dot{y}'_2) \mu_x N_{2xy}; \\ m_3 \ddot{x}'_3 = -k_x x'_3 - c_{x1} \dot{x}'_3 + \text{sign}(\dot{y}'_3) \mu_x N_{3xy}; \\ y'_1 = x'_1; y'_2 = x'_2; y'_3 = x'_3. \end{array} \right. \quad (1)$$

The law of the movement for the working body 4:

$$-M\ddot{y} = -Mg + N_{1,4}(t) - \delta k((L - y') + y'_0) + N_{45}, \quad (2)$$

where  $M$  – the mass of the working body 4;

$\delta$  – the number of return springs with the rigidity  $k$  with the initial tension  $y'_0$ ;

$L$  – internal height of the inertial ramp;

$N_{45}$  – is the force of the gan working reaction 4 from the contact interaction with the inertia mass 5.

The law of motion for the inertial mass  $M_{ih}$  is:

$$\begin{aligned} -M_{ih}(\ddot{y}' + \ddot{y}) &= -M_{ih}g + \delta k((L - y') + y'_0) - \\ - \iint_S p_s(t) dS + c\dot{y}' + N_{2y} + N_{1y} + c_2 \dot{y}'_2 - \\ - k_2(|y''|_2 + y''_0), \end{aligned} \quad (3)$$

where  $p_s(t)$  – is the changing the pressure function of the working fluid in the internal cavity of a two-stage pulsator valve,

$\iint_S p_s(t) dS$  – forces acting on the inner surface  $S'$  of the

inertial mass  $M_{ih}$ ,

$c_2$  – is the coefficient of viscous friction between the walls of the inertial mass 5 and the piston of the working body 4 (see Fig. 2),

$N_{2y}$  – is the vertical component of the reaction force of the conical support from the conical valve of the second stage 7,

$N_{1y}$  – is the vertical component of the reaction force of the cylindrical and conical surfaces valve of the first cascade 6,

$c_2$  – is the coefficient of viscous friction between the walls of the inertial mass 5 and the valve of the other cascade (see Fig. 2),

$k_2$  – is the spring stiffness of the valve of the second cascade,

$k_2$  – is the preload of the valve spring of the second cascade.

Since the valve of the first cascade 6 along the  $y$  axis always moves together with the inertial mass 5, it is therefore advisable to record the law of motion of the valve of the first cascade with mass  $M_1$  only for the  $x$  axis:

$$-M_1 \ddot{x}'_1 = -N_{1x} + k_1(|\ddot{x}'_1| + x''_0) - \iint_S p_s(t) dS + c_1 \dot{x}'_1, \quad (4)$$

where  $p_s(t)$  – the function of pressure change of the working fluid in the internal cavities  $C$  and  $D$  of the two-stage pulsator valve;

$\iint_S p_s(t) dS$  – forces acting on the inner surface of the

inertial mass  $S'$ ;

$c_1$  – is the coefficient of viscous friction forces between the walls of the inertial mass 5 and the piston of the working body 4 (see Fig. 2);

$N_{1x}$  – is the reaction force of the conical support from the conical valve 7, moreover  $N_{1x} = |N_{1y}|$ , since the conical surface is made at an angle of  $45^0$  to the  $y$  axis.

The law of movement for the second cascade valve of mass  $M_2$ :

$$-M_2(\ddot{y}''_2 + \ddot{y}'' + \ddot{y}) = -M_2g - \iint_S p_s(t) dS - N_{2y} - \quad (5)$$

$$-c_2 \dot{y}''_2 + k_2(|y''|_2 + y''_0),$$

where  $p_s(t)$  – is the function of changing the pressure of the working fluid in the internal cavities  $A$  and  $B$  of the two-stage valve-pulsator;

$\iint_S p_s(t) dS$  – forces acting on the outer surface of the

valve of the second cascade  $S''$ ;

$c_2$  – is the coefficient of viscous friction forces between the walls of the inertial mass 5 and the piston of the working element 4 (see Fig. 1);

$N_{2y}$  – reaction forces of the conical surface of the valve of the second cascade from the conical seat of the inertia mass 5.

In this case, the inertial forces of the working fluid acting on the operating organs of the inertial vibratory rammer are neglected, as bearing a small contribution to the change in the motion of the inertial vibratory rammer in general.

In order to write down a completely mathematical model of the operation of the inertial vibratory rammer, the operation of the HID at the appropriate working phases of the two-stage valve-pulsator should be considered.

1. Phase of pressure set. In this phase, the conical valves with masses  $M_1$  and  $M_2$  are at rest, and the conical valve  $M_1$  blocks the pressure cavities  $A$ ,  $B$  and  $C$  from the drain cavity  $D$  (see Fig. 1). It leads to a set of pressure in the pressure cavity  $A$ , so the main pressure  $p_s(t)$  acts on the area  $(S - S_0)$ . It should be noted that this phase occurs during the period of time  $t_1$ , when the mobile body 4 contacts the surface of the upper soil layer 1. At this phase, the inertial mass  $M_{in}$ . And at this stage there is a joint movement of the inertial mass  $M_{in}$  and locking elements of mass  $M_1$  and  $M_2$ .

For this phase  $t_2 \leq t \leq t_{mm}$  we write the following conditions:

$$\left\{ \begin{array}{l} \iint_{S'} p_s(t) dS \leq k_1 x_{01}''; \quad \iint_{S'} p_s(t) dS < k_2 y_{01}''; \\ y_2''(t) = y_1''(t) = 0; \quad \dot{y}_2''(t) = \dot{y}_1''(t) = \dot{y}'(t); \\ x_1''(t) = 0; \quad 0 \geq y_1'(t) \geq y'_{1max}; \quad N_{45} = 0, \end{array} \right. \quad (6)$$

where  $y'_{1max}$  – maximum stroke of inertial mass  $M_{in}$ .

2. Phase of operation (opening) of a two-stage pulsator valve. At this phase, the force from the pressure  $\iint_{S'} p_s(t) dS$  acting on the area  $S_1$  of the valve of the first cascade 6 is equalized with the tension force of the adjusting spring  $k_1 x_{01}''$ , that is:

$$\iint_{S'} p_s(t) dS \geq k_1 x_{01}'' \quad (7)$$

leading to open it. When the valve of the first cascade 6 is opened, the pressure cavity  $C$  communicates with the drain cavity  $D$ . This cavity message results in the relative velocity of the working fluid in the internal cavity of the two-stage pulsator valve. In turn, the fluid velocity in the internal cavity of a two-stage pulsator valve causes a pressure drop in the pressure cavities  $A$  and  $B$  due to the presence of a throttle hole in the valve of the second stage 7. The pressure different in the pressure cavities  $A$  and  $B$  results in the appearance of a force cascade move. When it happens, it is in the opening of this valve and, accordingly, the message of the pressure cavity  $A$  and drain cavity  $D$ .

At this phase, the inertial mass  $M_{in}$  also moves to the maximum displacement  $y'_{1max}$ , the valve of the first

cascade  $M_1$  to the maximum opening  $x''_{1max}$  and the valve of the second cascade  $M_2$  to the maximum opening. Therefore, for this phase  $t_{mm} \leq t \leq t_{cn}$ , there are got the following conditions:

$$\left\{ \begin{array}{l} \iint_{S'} p_s(t) dS > k_1 x_{01}''; \quad \iint_{S'} p_s(t) dS \geq k_2 y_{01}''; \quad y_1''(t) = 0; \\ N_{1x} = 0; \quad \dot{y}_1''(t) = \dot{y}'(t); \quad 0 \geq x_1''(t) \geq x''_{1max}; \quad N_{45} = 0; \quad (8) \\ 0 \geq y_2''(t) \geq y''_{2max}; \quad N_{2y} = 0; \quad 0 \geq y_1'(t) \geq y'_{1max}. \end{array} \right.$$

3. Phase closing (lowering) of the two-stage valve-pulsator. At this phase, the working fluid is drained through the drain cavity  $D$  into the hydraulic tank 8. It causes a pressure drop in the pressure cavities  $A$ ,  $B$ ,  $C$ . At the same time, the valve of the first cascade with the mass  $M_1$  begins to descend to its original place, (the place of overlap of the pressure cavity  $C$  from  $D$ ). After the pressure cavity  $C$  has disconnected from the drain cavity  $D$ , the relative velocity of the working fluid in the internal cavity of the two-stage pulsator valve becomes zero. In turn, the relative immobility of the working fluid in the internal cavity of a two-stage pulsator valve causes pressure equalization in pressure cavities  $A$  and  $B$ . As a result of pressure equalization in pressure cavities  $A$  and  $B$ , the spring tension of the second stage valve  $k_2 (|y''_{12}| + y''_{02})$  causes the valve of the second stage 7 to return to its original position. When it occurs, there is the closing of the pressure cavity  $A$  from the drain cavity  $D$ .

At this phase, reverse movements of the inertial mass  $M_{in}$ , the valve of the first cascade  $M_1$  and the valve of the second cascade  $M_2$  to the initial position also occur. Therefore, for this phase  $t_{cn} \leq t \leq t_{sk}$ , here are the following conditions:

$$\left\{ \begin{array}{l} \iint_{S'} p_s(t) dS \geq k_1 x_{01}''; \quad \iint_{S'} p_s(t) dS \geq k_2 y_{01}''; \quad y_1''(t) = 0; \\ \dot{y}_1''(t) = \dot{y}'(t); \quad 0 \geq x_1''(t) \geq x''_{1max}; \quad 0 \geq y_2''(t) \geq y''_{2max}; \quad (9) \\ 0 \geq y_1'(t) \geq y'_{1max}; \quad N_{45} = 0; \quad N_{2y} = 0; \quad N_{1x} = 0. \end{array} \right.$$

After the end of the closing (lowering) phase of the two-stage pulsator valve, the inertial mass 5 returns to its original position with the acquired speed  $v_{in} = \dot{y}'_1(t_{sk})$ . When this occurs, the impact interaction with the working body 4 occurs. With impact interaction, the inertial mass 5 picks up the working body 4 and they together with the initial velocity  $v_{M5}$ , begin to move upwards (a model of an ordinary body thrown vertically upwards with some initial velocity [9]). The total speed of the entire inertial vibratory rammer  $v_M$  is determined from the law of conservation of momentum [10], namely:

$$v_m = \frac{(M_m + M_1 + M_2)}{(M_m + M_1 + M_2 + M)} v_m. \quad (10)$$

The movement of the working body 4 should be considered for two cases, namely: when the mobile body 4 contacts the surface of the upper soil layer 1 and when the working body 1 does not contact the surface of the upper soil layer 1 (the jump mode after the shock interaction of the inertial mass 5 and the working body 4).

Conditions working body motion 4 for the jump period

$$t_1 \leq t \leq t_2 \quad (11)$$

after the shock interaction of the inertial mass 5 and the working body 4 (no contact of the working body 4 with the surface of the topsoil 1) for two cases, namely:

$$\begin{cases} \delta ky'_0 > \iint_S p_s(t) dS; & y'(t_3) = 0; \\ \dot{y}(t_1) = v_m; & N_{14}(t) = 0; \end{cases} \quad (12)$$

$$\begin{cases} \delta ky'_0 \leq \iint_S p_s(t) dS; \\ N_{14}(t) = 0; & N_{28}(t) = 0. \end{cases} \quad (13)$$

Conditions working body motion 4 for the period  $t_0 \leq t \leq t_1$  ( $t_0$  – is the beginning of the countdown of the inertial vibratory ramming operation) of the working body 4 contacting the surface of the topsoil 1. In this case, two cases must also be considered:

$$\begin{cases} t = t; & \delta ky' > \iint p(t) dS; \\ \dot{y}(t) = -v; & y'(t) = 0, \end{cases} \quad (14)$$

where  $t_2 - t_1 = 2v_m/g$  – flight time inertial vibratory rammer.

To determine the pressure change in the HID cavity, it is necessary to supplement the above laws of motion with the Navier-Stokes system of equations and the continuity equation (15, 16) for weakly squeezed fluids.

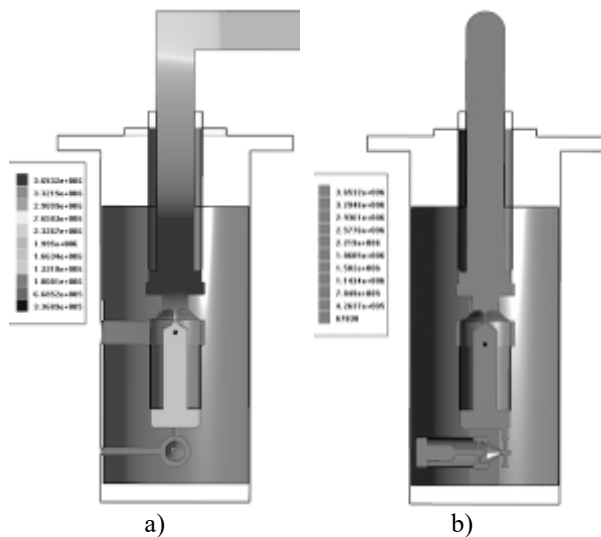
In this system of equations (15, 16)  $\Omega \in R^3$  – is the three-dimensional region (internal cavity of the HID) in which the working fluid moves,  $\rho_0$  – is the initial density of the working fluid,  $p_0$  – is the initial pressure of the working fluid,  $Q_H$  – is the flow rate of the hydraulic pump when fed into the pressure cavity through inlet pipe,  $S_0$  – cross-sectional area of the inlet pipe of the HID.

$$\left\{ \begin{aligned} & \frac{1}{\rho} \frac{d\rho}{dt} + \frac{\partial V}{\partial x''} + \frac{\partial V}{\partial y''} + \frac{\partial V}{\partial z''} = 0; \\ & \frac{\partial V}{\partial t} + \left( V \frac{\partial V}{\partial x''} + V \frac{\partial V}{\partial y''} + V \frac{\partial V}{\partial z''} \right) = -\frac{1}{\rho} \frac{\partial p}{\partial x''} + \\ & + \frac{v}{3} \frac{\partial}{\partial x''} \left( \frac{\partial V}{\partial x''} + \frac{\partial V}{\partial y''} + \frac{\partial V}{\partial z''} \right) + \\ & + v \left( \frac{\partial V}{\partial x''} + \frac{\partial V}{\partial y''} + \frac{\partial V}{\partial z''} \right); \\ & \overline{V} \Big|_{d\Omega} = 0; \quad \Omega \in R^3; \\ & \overline{V} \Big|_{t=0, z''=0, y''=0, x''=0} = Q_H / S_0; \end{aligned} \right. \quad (15)$$

$$\left\{ \begin{aligned} & \frac{\partial V_x}{\partial t} + \left( V_x \frac{\partial V_x}{\partial x''} + V_y \frac{\partial V_x}{\partial y''} + V_z \frac{\partial V_x}{\partial z''} \right) = -\frac{1}{\rho} \frac{\partial p}{\partial y''} + \\ & + \frac{v}{3} \frac{\partial}{\partial y''} \left( \frac{\partial V_x}{\partial x''} + \frac{\partial V_y}{\partial y''} + \frac{\partial V_z}{\partial z''} \right) + \\ & + v \left( \frac{\partial^2 V_x}{\partial x''^2} + \frac{\partial^2 V_x}{\partial y''^2} + \frac{\partial^2 V_x}{\partial z''^2} \right); \\ & \frac{\partial V_z}{\partial t} + \left( V_x \frac{\partial V_z}{\partial x''} + V_y \frac{\partial V_z}{\partial y''} + V_z \frac{\partial V_z}{\partial z''} \right) = -\frac{1}{\rho} \frac{\partial p}{\partial z''} + \\ & + \frac{v}{3} \frac{\partial}{\partial z''} \left( \frac{\partial V_x}{\partial x''} + \frac{\partial V_y}{\partial y''} + \frac{\partial V_z}{\partial z''} \right) + \\ & + v \left( \frac{\partial^2 V_z}{\partial x''^2} + \frac{\partial^2 V_z}{\partial y''^2} + \frac{\partial^2 V_z}{\partial z''^2} \right); \quad \rho \Big|_{t=0, \Omega} = \rho_0. \\ & \rho \Big|_{t=0, \Omega} = \rho_0 + \left( \frac{(m + m_0 + m_3)g + ky'_0}{(S - S_0)} \right). \end{aligned} \right. \quad (16)$$

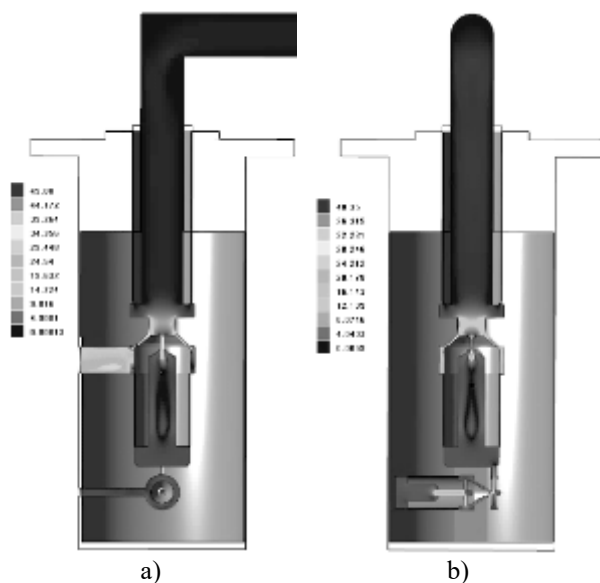
A mathematical model of the technological process of surface compaction of inertial vibratory rammer, represented by the systems of equations (1) - (16), was implemented by numerical simulation methods based on the FlowVision [11] and Matlab-Simulink [12] software systems. The simulation results are the pressure distribution in the working cavity of the HID inertial vibratory rammer (Fig. 3).

From Figure 3 it can be seen that the throttle 14 mounted in the valve of the second cascade 10 (see Fig. 1) makes a significant character in the pressure change (2 MPa) in the cavity between the valve of the first 11 and the second 10 cascades (see Fig. 1).



**Figure 3 – Pressure distribution in the working cavity of inertial vibratory rammer based on the HID:**  
a) in the  $yOz$  plane; b) in the  $yOx$  plane

Also, one of the simulation results is the distribution of pressure and velocity in the working cavity of the HID inertial vibratory rammer (Fig. 4).



**Figure 4 – Velocity distribution of the working fluid in the cavity of inertial vibratory rammer based on the HID:**  
a) in the  $yOz$  plane; b) in the  $yOx$  plane

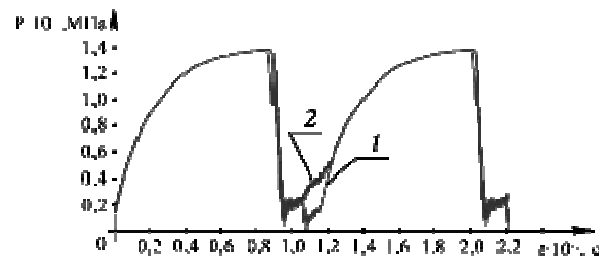
Analyzing Figure 4, it can be observed extreme values of speeds in the valvessets of the first 11 and second 10 stages, respectively (see Fig. 1), as well as at the throttle bore 14. These extreme speeds can cause cavitation phenomena that can adversely affect technical state of HID parts.

Numerical modeling of hydrodynamic processes of the HID inertial vibratory rammer enabled to obtain:

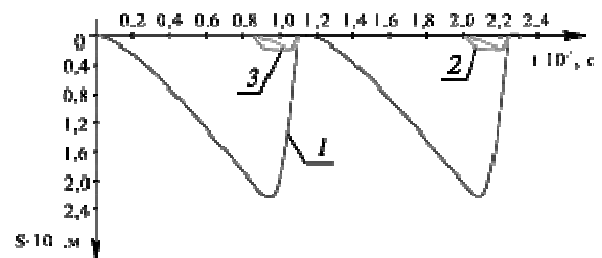
1) diagrams of pressure changes (Fig. 5) in working cavities *A* and *B* (see Fig. 2);

2) changes in movement (Fig. 6) of the housing of a two-stage pulsator valve 8, valve of the second stage 10 and valve of the first stage 11 relative to tamping plate 1 (see Fig. 1);

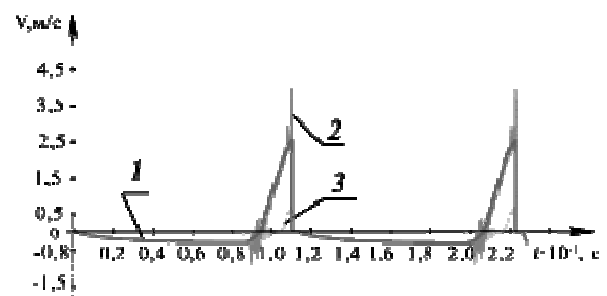
3) changes in the speed (Fig. 7) of the housing of the two-stage pulsator valve 8, the valve of the second stage 10 and the relative valve of the first stage 11 relative to the tamping plate 1 (see Fig. 1).



**Figure 5 – The pressure distribution of the working fluid in the empty inertial vibrating rammer based on the HID:**  
1 – in cavity *A*; 2 – in the plane *B*

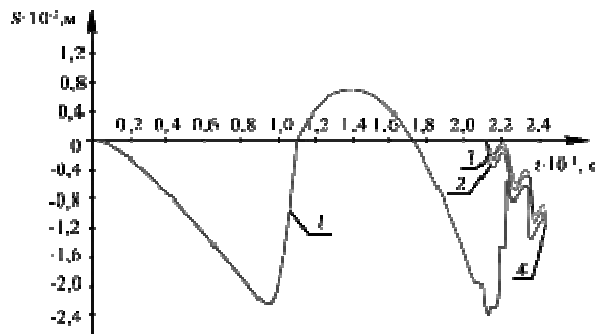


**Figure 6 – Changing the movement of moving elements of inertial vibratory rammer based on the HID:**  
1 – the body of the two-stage valve-pulsator 8;  
2 – valve of the second cascade 10;  
3 – valve of the first cascade 11



**Figure 7 – Changing the speed of moving elements of inertial rammer based on the HID:**  
1 – the body of the two-stage valve-pulsator 8;  
2 – valve of the second cascade 10;  
3 – valve of the first cascade 11

Additional absolute displacement diagrams (Fig. 8) of the two-stage pulsator valve 8 body were obtained, taking into account the jump of inertial vibrating rammers over the soil surface 2, as well as the mass' centers of soil layers 1, 2, 3 of the loam type [10] (see Fig. 2).



**Figure 8 – Change in the absolute movement on technological objects of surface soil compaction:**

- 1 – two-stage valve-pulsator housing;
- 2 – the mass' center of the soil layer 1;
- 3 – the mass' center of the soil layer 2;
- 4 – the mass' center of the soil layer 3

From the absolute displacement diagram for the mass centers of soil layers 1, 2, 3 of the loam type, it can be seen that the maximum deformation of the soil surface (upper layer 1) is 1.2 cm at an oscillation frequency of inertial mass 5 (see Fig. 2) 8.7 Hz.

## Conclusions

An effective design of inertial vibrating rammers, based on a two-stage pulsator valve, has been developed. It enables to implement the most effective modes of vibration exposure with surface compaction of the soil.

On the basis of the hydrodynamics laws with the use of mechanical rheological phenomenology and generalized laws of mechanics, a new mathematical model has been developed for the study of technological processes of surface soil compaction with inertial vibratory rammer.

On the basis of the developed mathematical model, using the method of finite volumes using numerical simulation, the working dependences for determining the basic performance characteristics of the technological process of surface soil compaction using inertial vibratory rammer based on the HID are obtained.

The obtained results of numerical simulation for technological processes of surface soil compaction by the inertial vibratory rammer based on the HID. They showed the advantages of the chosen design approach, and also allowed to prove the effectiveness of the developed HID design, based on a two-stage pulsator valve.

## References

1. Іскович-Лотоцький, Р.Д., Іванчук, Я.В. (2008). Застосування вібраційного гідроімпульсного привода в будівельних і дорожніх машинах. *Збірник наукових праць Харківської державної академії залізничного транспорту*, 88, 48-54.
2. Wicher, P., Zapletal, F., Lenort, R. & Staš, D. (2016). Measuring the metallurgical supply chain resilience using fuzzy analytic network process. *Journal of Metalurgija*, 55(4), 783-786.
3. Hou, Y.J., Du, M.J., Fang, P. & Zhang, L.P. (2017). Synchronization and stability of an elastically coupled tri-rotor vibration system. *Journal of theoretical and applied mechanics*. 55(1). 227-240.  
<http://dx.doi.org/10.15632%2Fjtam-pl.55.1.227>
4. Guang, L. & Min, W. (2005). Modeling and controlling of a flexible hydraulic manipulator. *Journal of Central South University of Technology: Science & Technology of Mining and Metallurgy*, 12(5), 578-583.
5. Cheng, C., Chen, H., Shi, Z., Liu, Z. & Xiong, Y. (2016). Modeling and controlling of a flexible hydraulic manipulator. *Journal of Shock and Vibration*, 16, 1-9.
6. Cheng, C., Chen, H., Shi, Z., Liu, Z. & Xiong, Y. (2016). System-level coupled modeling of piezoelectric vibration energy harvesting systems by joint finite element and circuit analysis. *Journal of Shock and Vibration*. 2016, 1-9.  
<http://dx.doi.org/10.1155/2016/2413578>
7. Іскович-Лотоцький, Р.Д., Зелінська, О.В., Іванчук, Я.В. (2018). *Технологія моделювання оцінки параметрів формування заготовок з порошкових матеріалів на вібропресовому обладнанні з гідроімпульсним приводом*. Вінниця: ВНТУ.
8. Jacob, K. (1994). Hurwitz stability of weighted diamond polynomials. *Journal of Systems & Control Letters*, 22(4), 303-312.  
[https://doi.org/10.1016/0167-6911\(94\)90062-0](https://doi.org/10.1016/0167-6911(94)90062-0)
1. Iskovich-Lototsky, R.D. & Ivanchuk, E.V. (2008). Application of vibration hydro-impulse actuator in construction and road machines. *Proceedings of Kharkiv State Academy of Railway Transport*, 88, 48-54.
2. Wicher, P., Zapletal, F., Lenort, R. & Staš, D. (2016). Measuring the metallurgical supply chain resilience using fuzzy analytic network process. *Journal of Metalurgija*, 55(4), 783-786.
3. Hou, Y.J., Du, M.J., Fang, P. & Zhang, L.P. (2017). Synchronization and stability of an elastically coupled tri-rotor vibration system. *Journal of theoretical and applied mechanics*. 55(1). 227-240.  
<http://dx.doi.org/10.15632%2Fjtam-pl.55.1.227>
4. Guang L. & Min, W. (2005). Modeling and controlling of a flexible hydraulic manipulator. *Journal of Central South University of Technology: Science & Technology of Mining and Metallurgy*, 12(5), 578-583.
5. Cheng, C., Chen, H., Shi, Z., Liu, Z. & Xiong, Y. (2016). Modeling and controlling of a flexible hydraulic manipulator. *Journal of Shock and Vibration*, 16, 1-9.
6. Cheng, C., Chen, H., Shi, Z., Liu, Z. & Xiong, Y. (2016). System-level coupled modeling of piezoelectric vibration energy harvesting systems by joint finite element and circuit analysis. *Journal of Shock and Vibration*. 2016, 1-9.  
<http://dx.doi.org/10.1155/2016/2413578>
7. Iskovich-Lototsky, R.D., Zelinskaya, O.V., Ivanchuk, Y.V. (2018). *Technology of modeling of estimation of parameters of forming of billets from powder materials on the vibropress equipment with the hydropulse actuator*. Vinnytsia: VNTU.
8. Jacob, K. (1994). Hurwitz stability of weighted diamond polynomials. *Journal of Systems & Control Letters*, 22(4), 303-312.  
[https://doi.org/10.1016/0167-6911\(94\)90062-0](https://doi.org/10.1016/0167-6911(94)90062-0)

9. Iskovich-Lototsky, R.D., Ivanchuk, Y.V. (2008). Підвищення ефективності розвантаження матеріалів під дією періодичних ударних імпульсів. *Вібрації в техніці і технологіях*, 2(51), 8-11.
10. Iskovich-Lototsky, R.D., Ivanchuk, Y.V., Veselovsky, Y.P. (2016). Оптимізація конструктивних параметрів інерційного вібропрес-молота. *Вісник машинобудування та транспорту*, 2, 43-50.
11. Iskovich-Lototsky, R.D., Ivanchuk, Y.V., Tesovsky, D.V., Veselovsky, J.P. (2012). Застосування гібридного моделювання при розробці установок для утилізації відходів. *Технологічні комплекси*, 1-2 (5-6), 122-126.
12. Wlosnewski, J.C., Kumpugdee-Vollrath, M. & Sriamornsak, P. (2010). Effect of drying technique and disintegrant on physical properties and drug release behavior of microcrystalline cellulose-based pellets prepared by extrusion/spheronization. *Chemical Engineering Research and Design*, 88(1), 100-108.  
<https://doi.org/10.1016/j.cherd.2009.07.001>.
13. Nazarenko, I., Ruchynskiy, M. & Delembovskyi, M. (2018). The basic parameters of vibration settings for sealing horizontal surfaces. *Journal of Engineering and Technology (UAE)*, 7 (3.2), 255-259.  
<http://dx.doi.org/10.14419/ijet.v7i3.2.14415>
14. Nesterenko, M., Nazarenko, I. & Molchanov, P. (2018). Cassette installation with active working body in the separating partition. *Journal of Engineering and Technology (UAE)*, 7(3.2), 265-268.  
<http://dx.doi.org/10.14419/ijet.v7i3.2.14417>
15. Nesterenko, M., Maslov, A. & Salenko, J. (2018). Investigation of vibration machine interaction with compacted concrete mixture. *Journal of Engineering and Technology (UAE)*, 7(3.2), 260-264.  
<http://dx.doi.org/10.14419/ijet.v7i3.2.14416>.
9. Iskovich-Lototsky, R.D. & Ivanchuk, Y.V. (2008). Improving the efficiency of unloading materials under the action of periodic shock pulses. *Vibrations in Engineering and Technology*, 2 (51), 8-11.
10. Iskovich-Lototsky, R.D., Ivanchuk, Y.V., Veselovsky, Y.P. (2016). Optimization of design parameters of inertial vibrating press hammer. *Bulletin of Mechanical Engineering and Transport*, 2, 43-50.
11. Iskovich-Lototsky, R.D., Ivanchuk, Y.V., Tesovsky, D.V. & Veselovsky, J.P. (2012). Application of hybrid modeling in the development of waste disposal facilities. *Technological Complexes*, 1-2 (5-6), 122-126.
12. Wlosnewski, J.C., Kumpugdee-Vollrath, M. & Sriamornsak, P. (2010). Effect of drying technique and disintegrant on physical properties and drug release behavior of microcrystalline cellulose-based pellets prepared by extrusion/spheronization. *Chemical Engineering Research and Design*, 88(1), 100-108.  
<https://doi.org/10.1016/j.cherd.2009.07.001>.
13. Nazarenko, I., Ruchynskiy, M. & Delembovskyi, M. (2018). The basic parameters of vibration settings for sealing horizontal surfaces. *Journal of Engineering and Technology (UAE)*, 7 (3.2), 255-259.  
<http://dx.doi.org/10.14419/ijet.v7i3.2.14415>
14. Nesterenko, M., Nazarenko, I. & Molchanov, P. (2018). Cassette installation with active working body in the separating partition. *Journal of Engineering and Technology (UAE)*, 7(3.2), 265-268.  
<http://dx.doi.org/10.14419/ijet.v7i3.2.14417>
15. Nesterenko, M., Maslov, A. & Salenko, J. (2018). Investigation of vibration machine interaction with compacted concrete mixture. *Journal of Engineering and Technology (UAE)*, 7(3.2), 260-264.  
<http://dx.doi.org/10.14419/ijet.v7i3.2.14416>.