

# Розробка підсилювача потужності

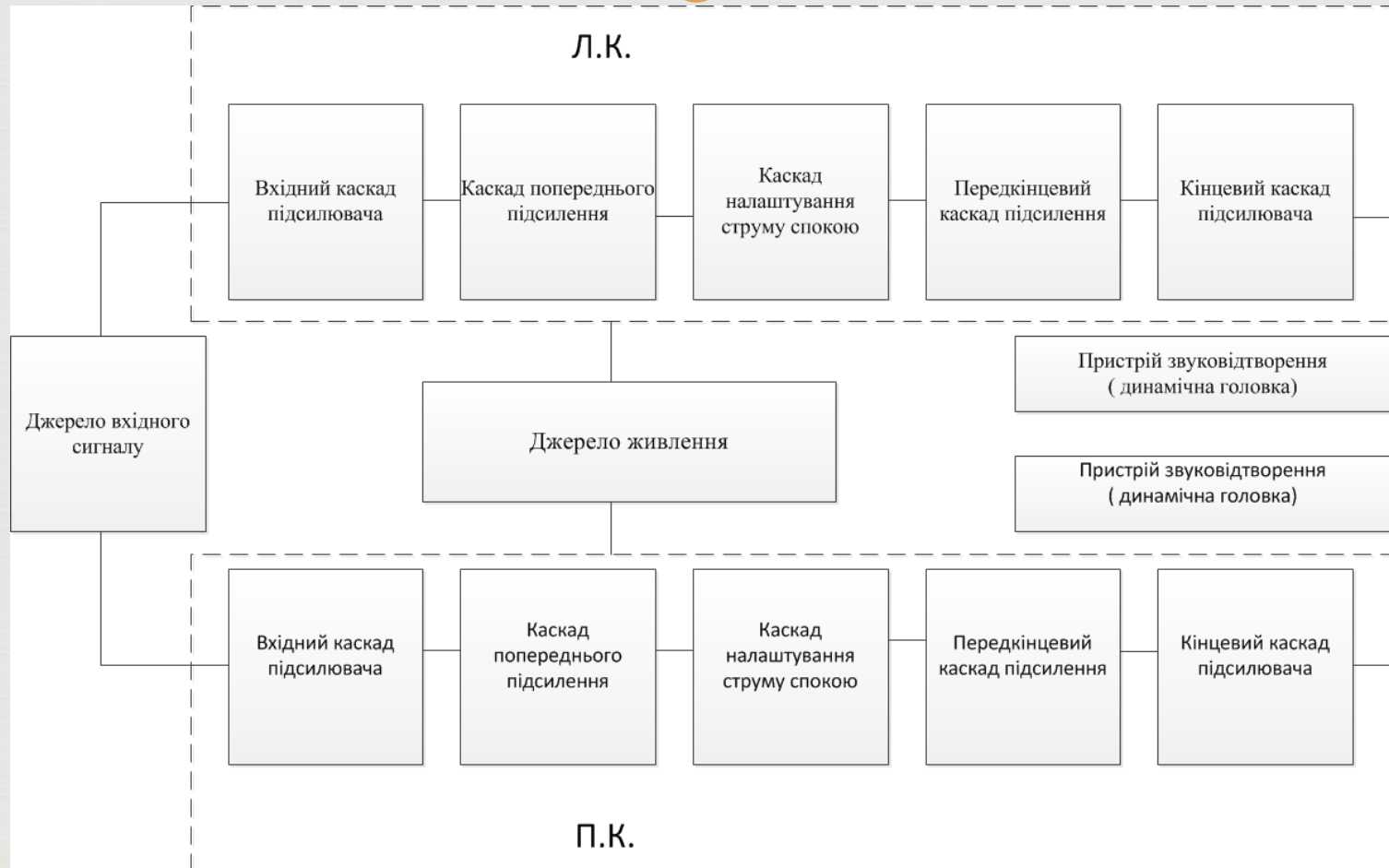

Виконав: ст. гр. ЕЗ-15<sub>сп</sub> Турчак О.О.  
Керівник: к.т.н., доц. Шеремета О.П.

# Структурна схема



# Схема електрична принципова

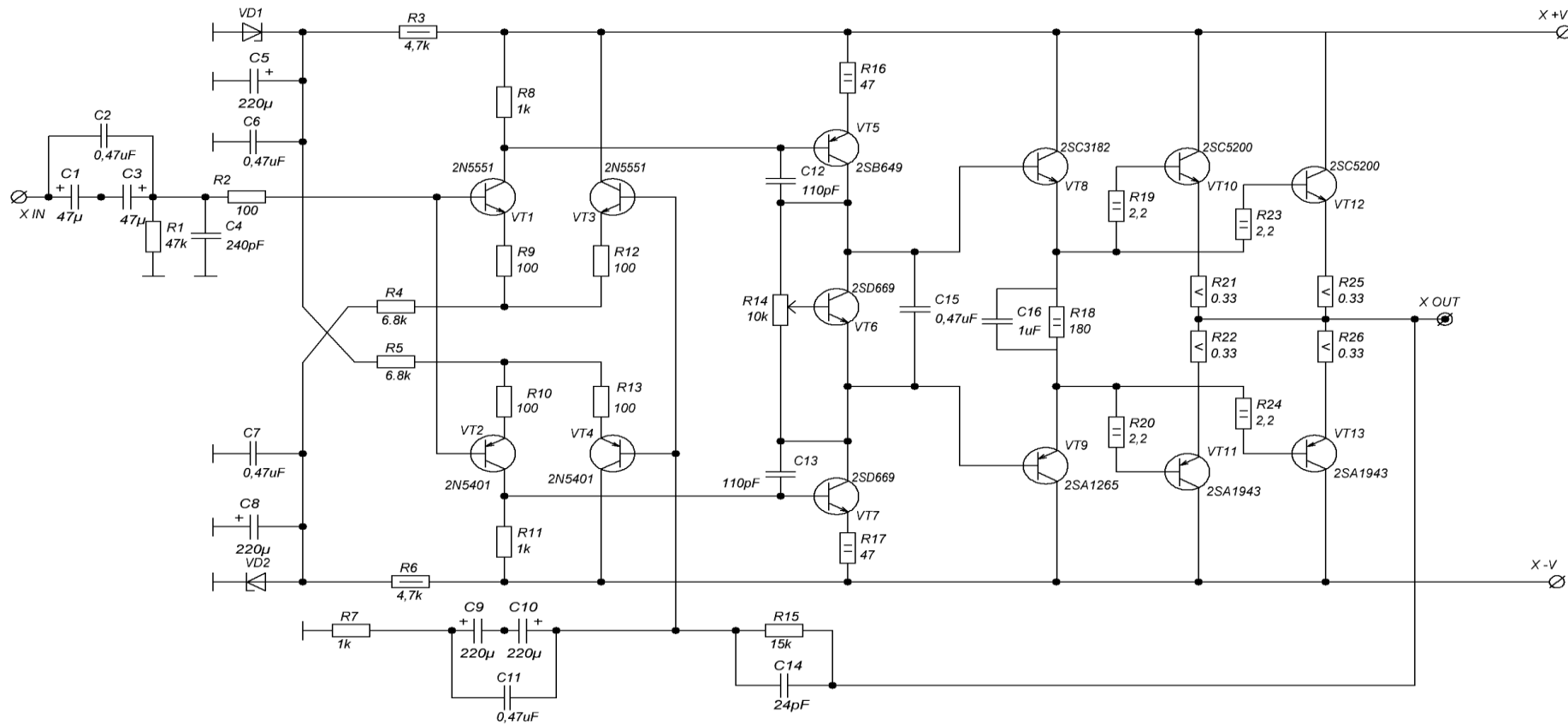

# Друкована плата пристрою

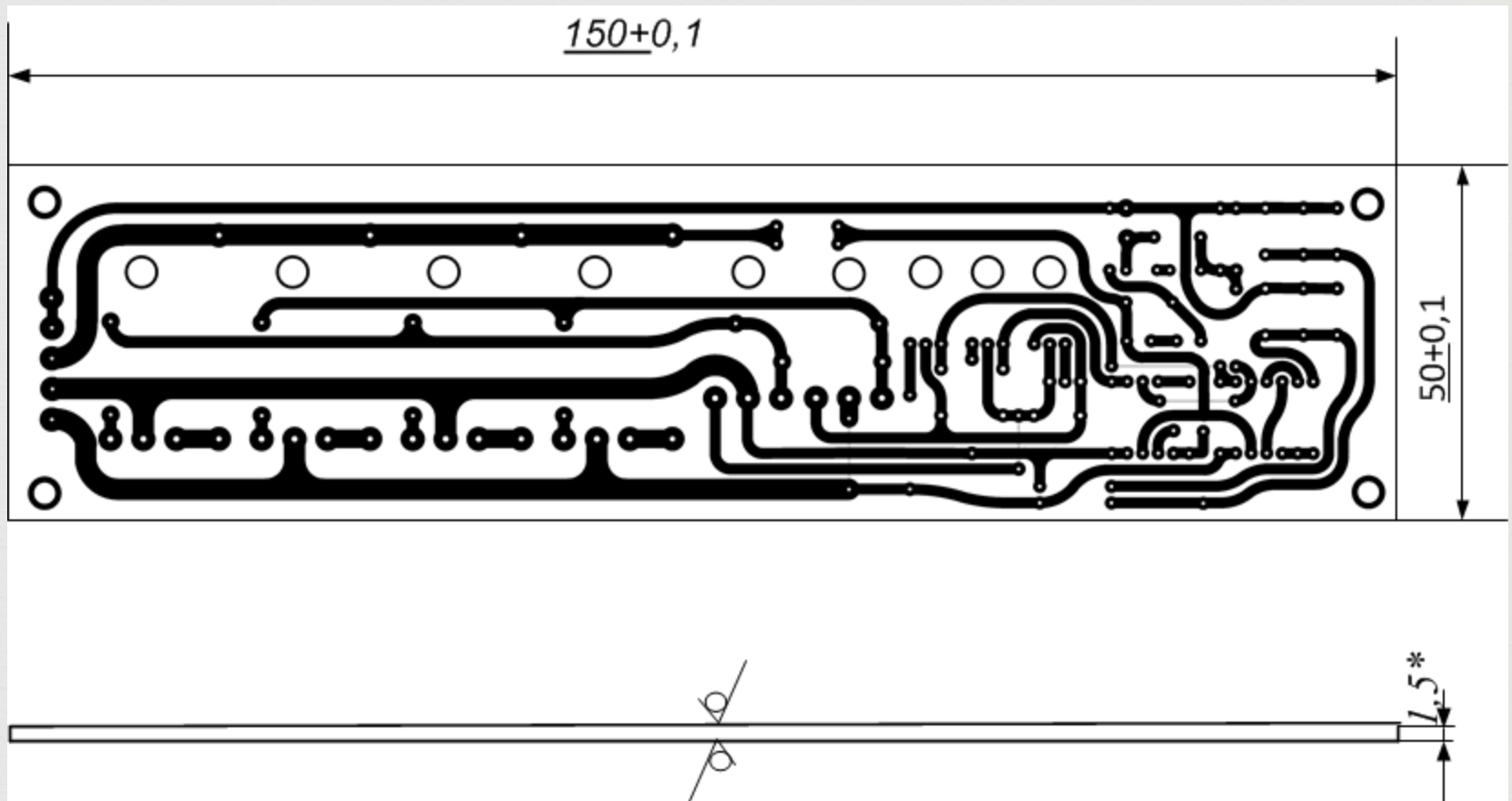

# Складальне креслення плати

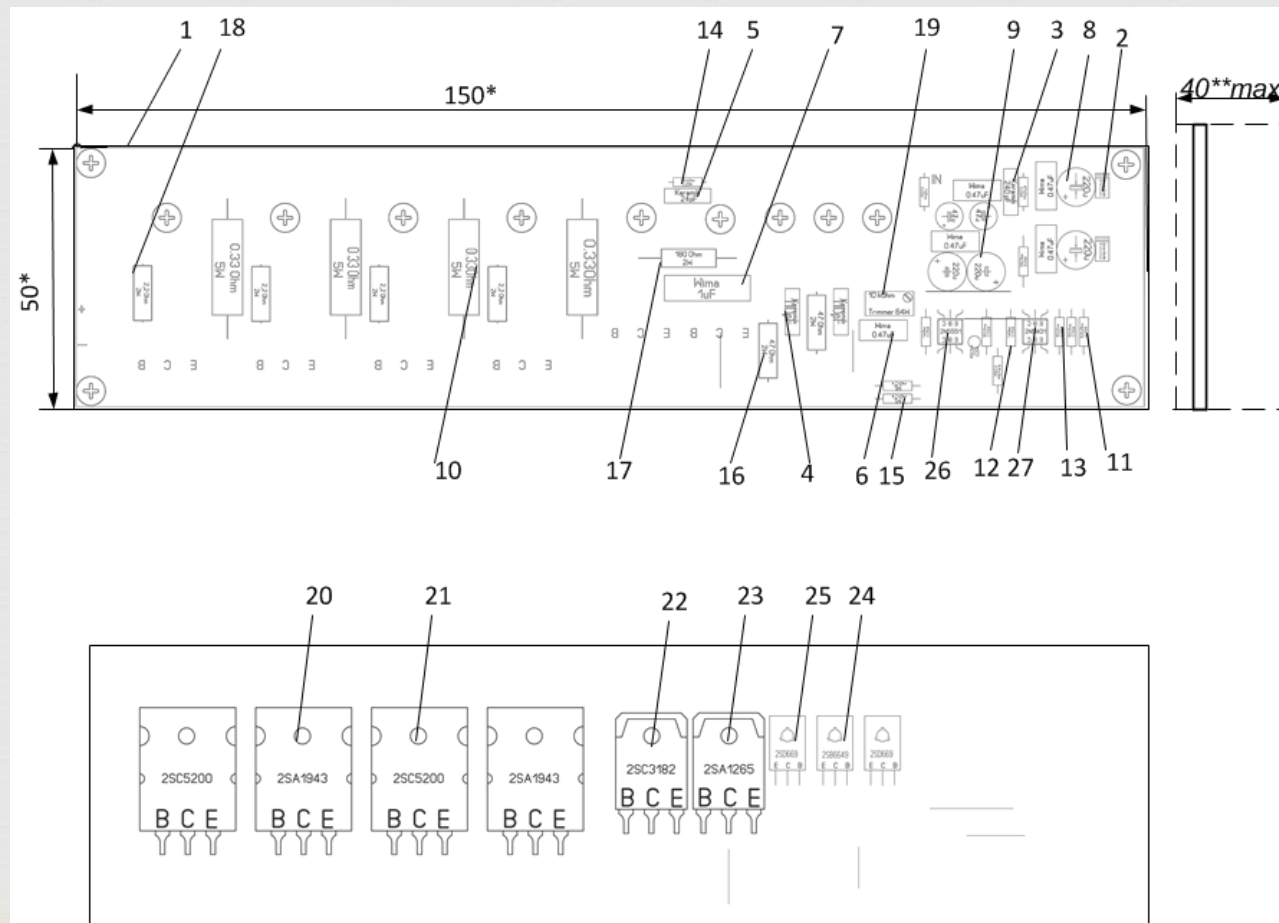



# Копныс

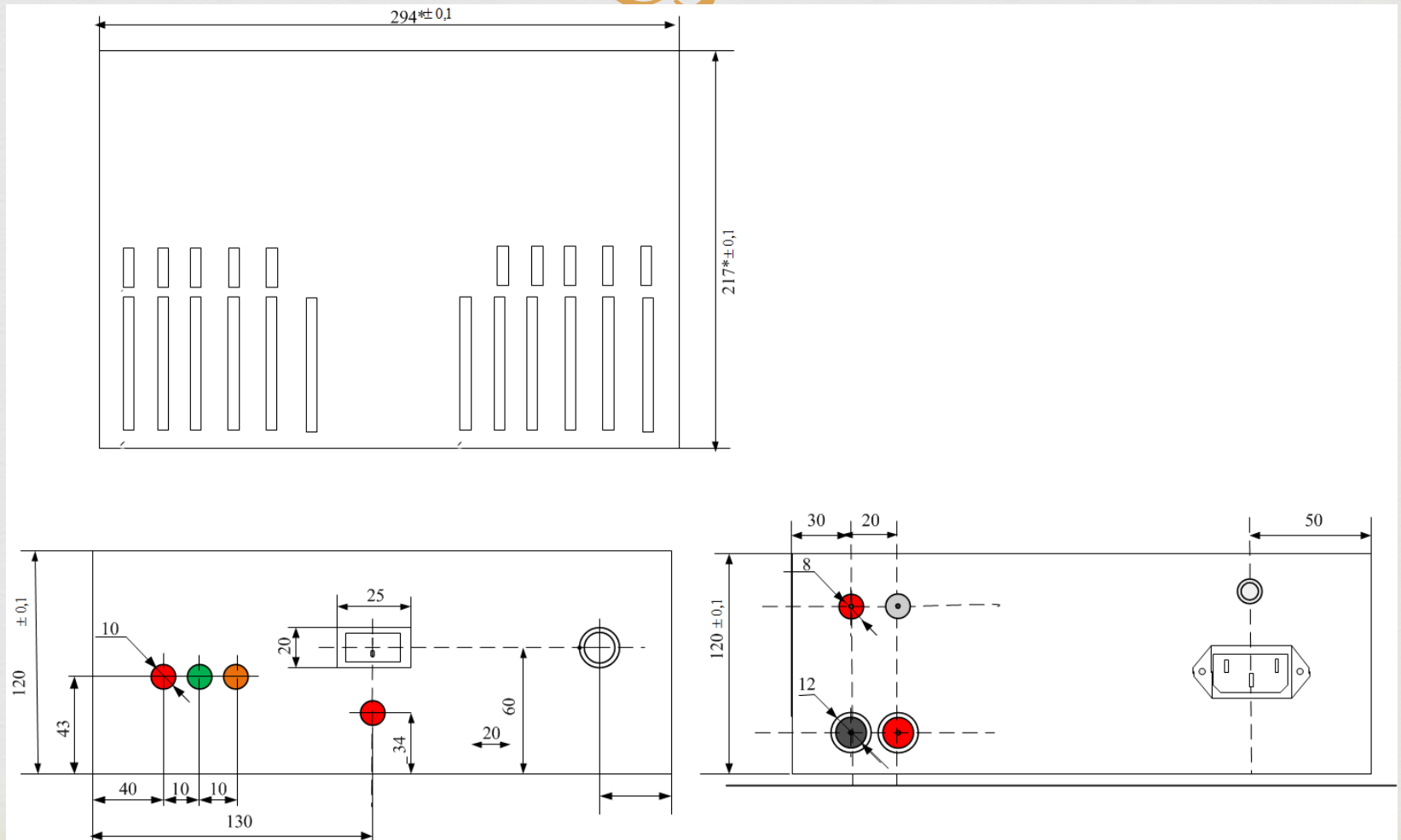

ИБЖ

Э



# *БЖ підсилювача*





# Плата захисту

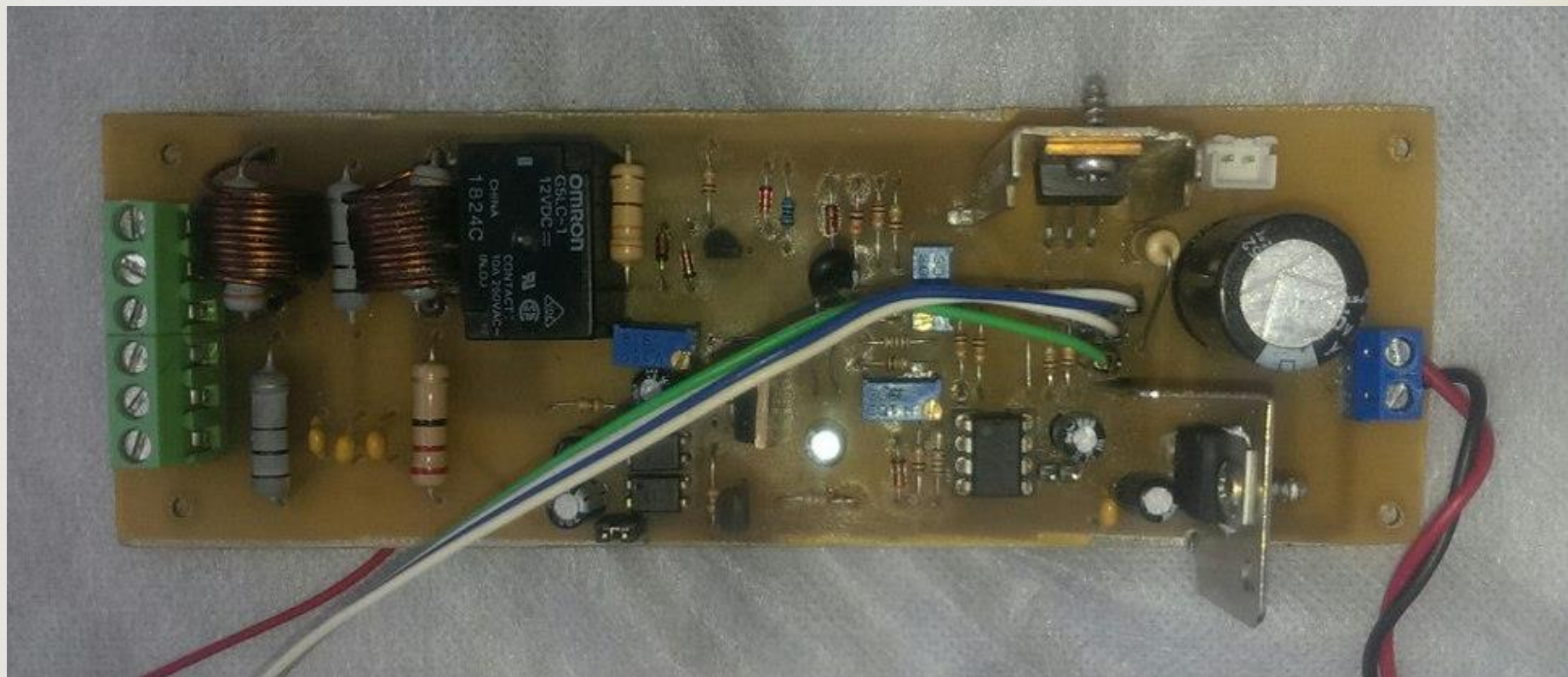

# Плата підсилювача

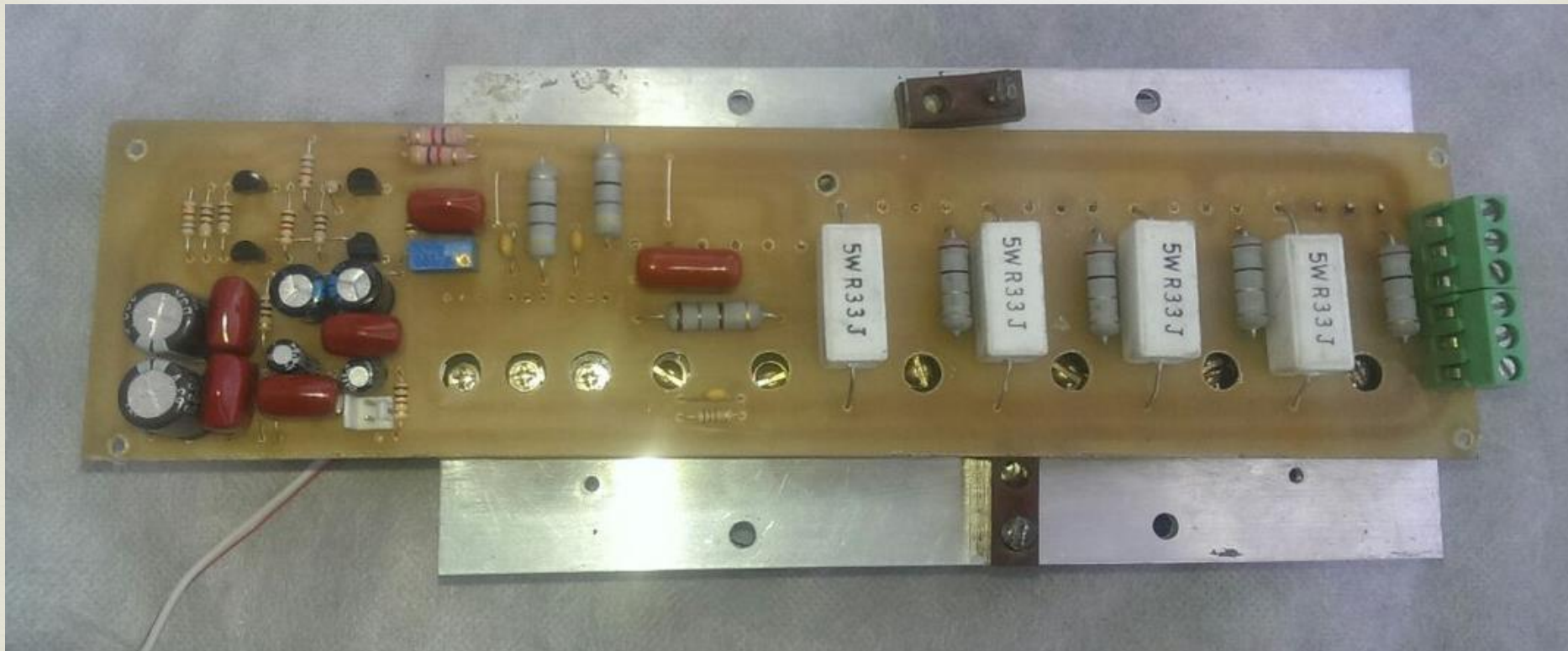



# Плата підсилювача

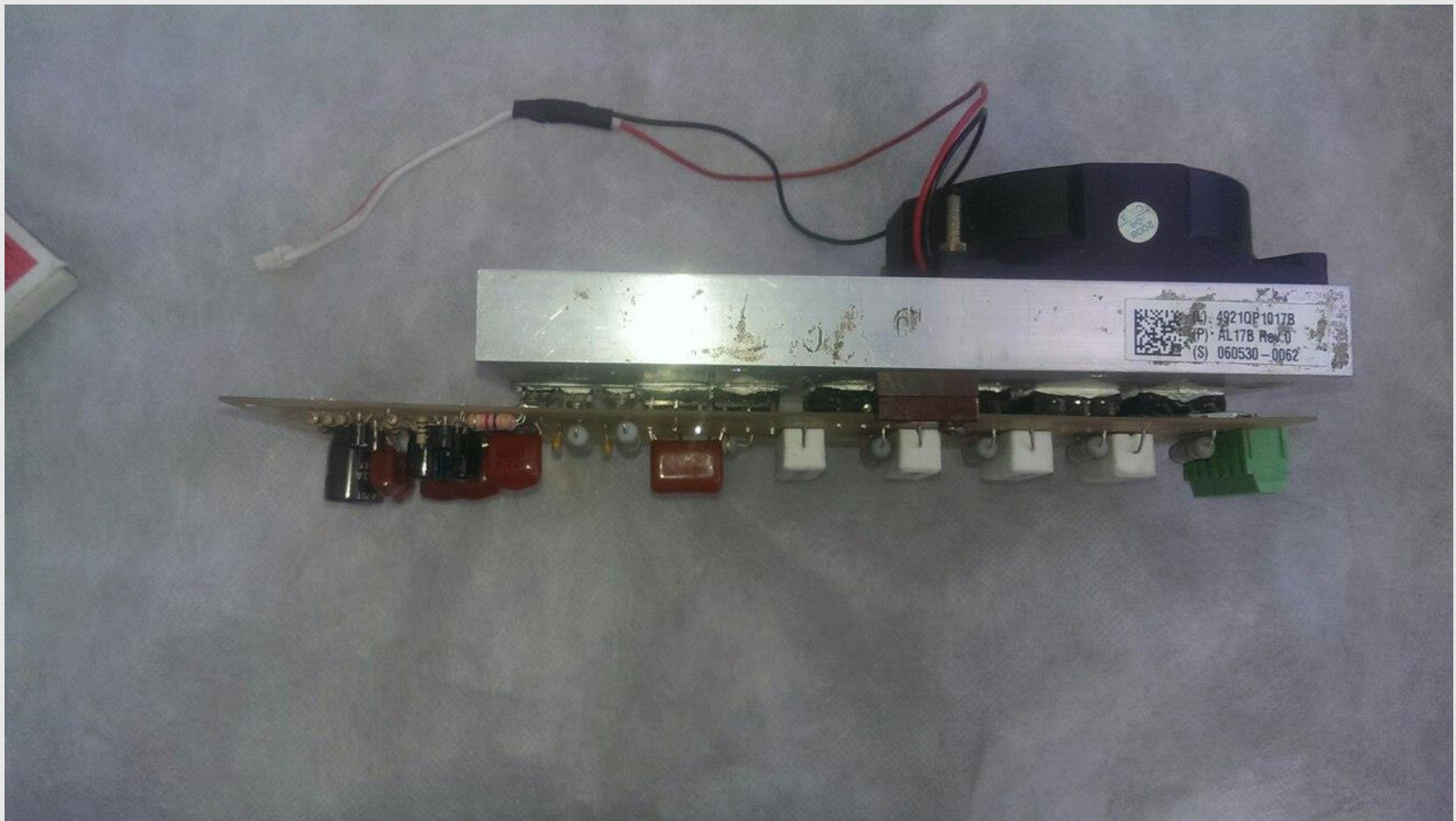

# Загальний вигляд (зверху)





# *Передня панель*



# *Задня панель*

*СЗ*

